

Pressione di lavoro: 10 bar
Filetti cilindrici: UNI-ISO 228/1 G
Filetti conici: UNI-ISO 7/1 R
Filetti metrici: ISO R/262M

Working pressure: 10 bar
Parallel Threads: BSP
Taper Threads: BSPT
Metric Threads: ISO R/262M

Legenda per la composizione delle sigle e varianti standard di silenzianti e regolatori di scarico silenzianti

How to compose standard descriptions and options of silencers and silenced exhaust speed regulators

Famiglia / Family

S = Silenzianti / Silencers
R = Regolatori / Regulators

Materiale (Variante)
 Material (Option)

X = Inox / Stainless steel
P = Nylon / Nylon

Filettatura (Variante)
 Thread (Option)

N = NPT
M = Metrica / Metric
F = Femmina / Female

Filetto metrico (variante M)
 indicare filetto - es: M10x1

Metric thread (Option M)
indicate thread - ex: M10x1

Articolo / Item
 da **01 a 22**
 from **01 to 22**

N = Nichelato / Nickel-plated
S = Speciale / Special

Misure filetti (standard BSP)
 Thread sizes (standard BSP)

M5 = M5

18 = 1/8

14 = 1/4

38 = 3/8

12 = 1/2

34 = 3/4

01 = 1

41 = 1-1/4

21 = 1-1/2

02 = 2

22 = 2-1/2

03 = 3

04 = 4

06 = 6

Per i codici ed articoli standard vedi tabelle delle pagine seguenti
For standard codes and items see tables on following pages

S01

Niplo: Ottone
Nipple: Brass

Parte filtrante: Bronzo sferico sinterizzato 36 µm
Filter: Spherical sintered bronze 36 µm



Ottone e bronzo Brass and bronze	Codice Code	Articolo Article	A	B	C	D	E	F	Prezzo € Price €	Confezione Order Q.ty
	10001	S01M5	M5	6	4,5	10	14,5	5		100
	10002	S0118	1/8"	12	6	16	22	8		100
	10003	S0114	1/4"	15	6	20	26	11		50
	10004	S0138	3/8"	19	8	30,5	38,5	15		50
	10005	S0112	1/2"	23	9	32	41	18		25
	10006	S0134	3/4"	31	10	33	43	28		10
	10007	S0101	1"	37	12	41	53	32		5
	10173	S01M10x1	M10x1	12	6	16	22	8		100

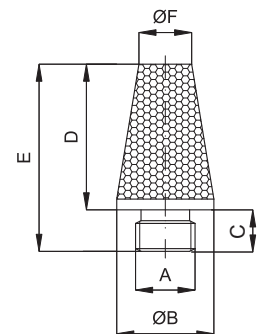

S02

Niplo: Ottone
Nipple: Brass

Parte filtrante: Bronzo sferico sinterizzato 36 µm
Filter: Spherical sintered bronze 36 µm



Ottone e bronzo Brass and bronze	Codice Code	Articolo Article	A	B	CH	C	D	E	Prezzo € Price €	Confezione Order Q.ty
	10008	S02M5	M5	12	7	4	16	20		100
	10009	S0218	1/8"	12	7	6	16	22		100
	10010	S0214	1/4"	15	9	6	20	26		50
	10011	S0238	3/8"	19	10	8	30	38		50
	10012	S0212	1/2"	23	14	9	32	41		25
	10013	S0234	3/4"	31	20	10	41	51		10
	10014	S0201	1"	37	23	12	48	60		5

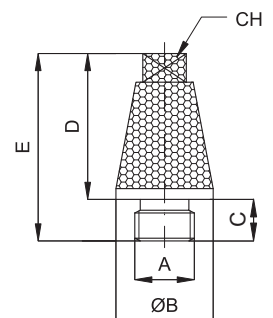



S03

 Niplo: Ottone
 Nipple: Brass

 Parte filtrante: Bronzo sferico sinterizzato 36 µm
 Filter: Spherical sintered bronze 36 µm

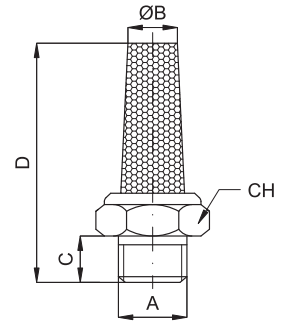
Ottone e bronzo Brass and bronze	Codice Code	Articolo Article	A	B	CH	C	D	Prezzo € Price €	Confezione Order Q.ty
	10015	S03M5	M5	4	8	4	16		100
	10216	S03M7	M7	4	8	5	19		100
	10016	S0318	1/8"	7,5	13	6	28		100
	10017	S0314	1/4"	9	16	8	32		50
	10018	S0338	3/8"	12	19	7,5	41		50
	10019	S0312	1/2"	16	24	10	46,5		25
	10020	S0334	3/4"	20,5	30	10	49		10
	10021	S0301	1"	21	36	10	58		5
	10152	SF0318	1/8"F	7,5	13	6	28		100

SX03

 Niplo: AISI 316
 Nipple: AISI 316

 Parte filtrante: AISI 316
 Filter: AISI 316

INOX Stainless steel	Codice Code	Articolo Article	A	B	CH	C	D	Prezzo € Price €	Confezione Order Q.ty
	10022	SX03M5	M5	4	9	5	21,5		50
	10023	SX0318	1/8"	8,5	12	7	28,5		50
	10024	SX0314	1/4"	10,5	15	9	33		50
	10025	SX0338	3/8"	12	19	9	40		25
	10026	SX0312	1/2"	16	23	9,5	48		20
	10027	SX0334	3/4"	22	30	11	58,5		10
	10028	SX0301	1"	27	36	15	71		5

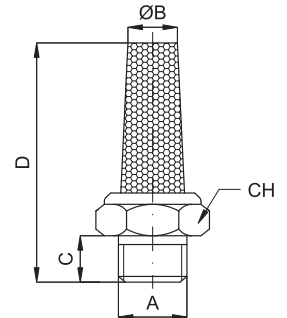
S04

 Niplo: Ottone
 Nipple: Brass

 Parte filtrante: Bronzo sferico sinterizzato 36 µm
 Filter: Spherical sintered bronze 36 µm

Ottone e bronzo Brass and bronze	Codice Code	Articolo Article	A	B	CH	C	D	Prezzo € Price €	Confezione Order Q.ty
	10029	S04M5	M5	4	8	4	24		100
	10030	S0418	1/8"	7	13	6	41,5		100
	10031	S0414	1/4"	8	16	8	52		50
	10032	S0438	3/8"	10	19	7,5	55		50
	10033	S0412	1/2"	14	24	10	67		25
	10034	S0434	3/4"	15	30	10	67		10
	10035	S0401	1"	20	36	10,5	78		5
	10174	S0421	1 1/2"	28	55	20	140		1
	10186	S0402	2"	36	65	17	215		1

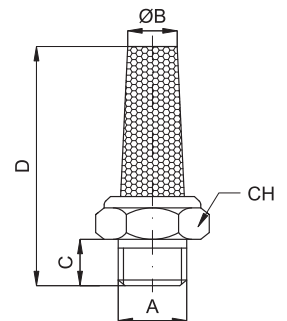
S05

 Niplo: Acciaio ramato
 Nipple: Copper plated steel

 Parte filtrante: Bronzo sferico sinterizzato 36 µm
 Filter: Spherical sintered bronze 36 µm

Acciaio ramato e bronzo Copper plated steel and bronze	Codice Code	Articolo Article	A	B	CH	C	D	Prezzo € Price €	Confezione Order Q.ty
	10036	S05M5	M5	5	7	3,5	18		100
	10037	S0518	1/8"	8,5	12	4,5	21		100
	10038	S0514	1/4"	11	15	6	27,5		50
	10039	S0538	3/8"	14	19	7	35		50
	10040	S0512	1/2"	17	23	8	42,5		25
	10041	S0534	3/4"	21	30	9	54		10
	10042	S0501	1"	26,5	36	11	67		5

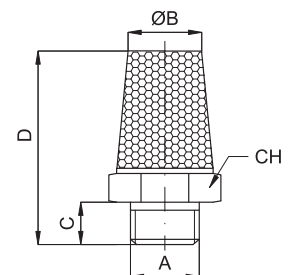

S07 Nipplo: Ottone **Parte filtrante:** Bronzo sferico sinterizzato 100 µm
 Nipple: Brass **Filter:** Spherical sintered bronze 100 µm



Ottone e bronzo Brass and bronze	Codice Code	Articolo Article	A	CH	C	D	Prezzo € Price €	Confezione Order Q.ty
	10046	S07M5	M5	8	4	8,5		100
	10310	S07M7	M7	8	5	10,5		100
	10047	S0718	1/8"	13	6	13		100
	10048	S0714	1/4"	16	8	17		50
	10049	S0738	3/8"	19	7,5	17		50
	10050	S0712	1/2"	24	10	19		25
	10051	S0734	3/4"	30	10	19		10
	10052	S0701	1"	36	10	20		5
	10153	SF0718	1/8"F	13	6	13		100

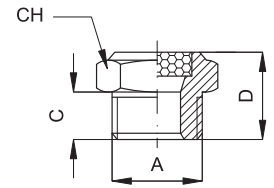

SX07 Nipplo: AISI 316 **Parte filtrante:** AISI 316
 Nipple: AISI 316 **Filter:** AISI 316



INOX Stainless steel	Codice Code	Articolo Article	A	CH	C	D	Prezzo € Price €	Confezione Order Q.ty
	10192	SX07M5	M5	8	5	10		50
	10193	SX0718	1/8"	12	7	14		50
	10194	SX0714	1/4"	15	9	16		50
	10195	SX0738	3/8"	19	9	16		25
	10196	SX0712	1/2"	23	9,5	19		20
	10197	SX0734	3/4"	30	11	21		10
	10198	SX0701	1"	36	15	26		5

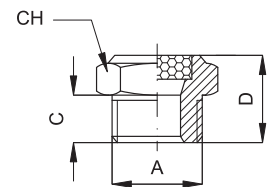

S08 Nipplo: Ottone **Parte filtrante:** Bronzo sferico sinterizzato 50 µm
 Nipple: Brass **Filter:** Spherical sintered bronze 50 µm



Ottone e bronzo Brass and bronze	Codice Code	Articolo Article	A	C	D	Prezzo € Price €	Confezione Order Q.ty
	10054	S0818	1/8"	6	4,5		100
	10055	S0814	1/4"	8	6,5		50
	10056	S0838	3/8"	9,5	7,5		50
	10057	S0812	1/2"	12,5	8,5		25
	10058	S0834	3/4"	19	8,5		10
	10059	S0801	1"	24	10,5		5

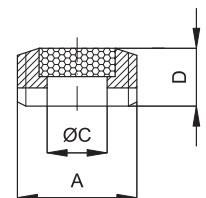

SX08 Nipplo: AISI 304 **Parte filtrante:** AISI 304
 Nipple: AISI 304 **Filter:** AISI 304



INOX Stainless steel	Codice Code	Articolo Article	A	C	D	Prezzo € Price €	Confezione Order Q.ty
	10061	SX0818	1/8"	6	4,5		100
	10062	SX0814	1/4"	8	6,5		50

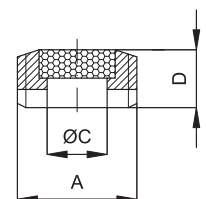

S09 Nipplo: Ottone **Parte filtrante:** Bronzo sferico sinterizzato 36 µm
 Nipple: Brass **Filter:** Spherical sintered bronze 36 µm



Ottone Brass	Codice Code	Articolo Article	A	B	C	D	Prezzo € Price €	Confezione Order Q.ty
	10067	S0918	1/8"	10	4	10		100
	10068	S0914	1/4"	13	6	15		50

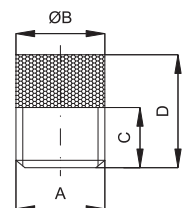

S10 Niplo: Ottone **Parte filtrante:** Bronzo sferico sinterizzato 36 µm
 Nipple: Brass **Filter:** Spherical sintered bronze 36 µm



Ottone e bronzo Brass and bronze	Codice Code	Articolo Article	A	B	C	D	Prezzo € Price €	Confezione Order Q.ty
	10073	S1018	1/8"	9	4	12,5		100
	10074	S1014	1/4"	12,5	6	14		50
	10075	S1038	3/8"	16	7,5	16		50
	10076	S1012	1/2"	20,5	10	19,5		25
	10077	S1034	3/4"	26	11	23		10
	10078	S1001	1"	33	13	24		5

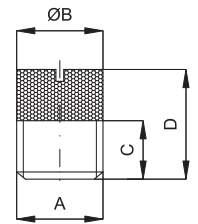

S11 Niplo: Ottone **Parte filtrante:** Rete acciaio inox AISI 304
 Nipple: Brass **Filter:** Net in stainless steel AISI 304



Ottone e inox Brass and inox	Codice Code	Articolo Article	A	CH	C	D	Prezzo € Price €	Confezione Order Q.ty
	10079	S11M5	M5	8	4	8,5		100
	10080	S1118	1/8"	13	6	15		100
	10081	S1114	1/4"	16	8	19		50
	10082	S1138	3/8"	19	7,5	19		50
	10083	S1112	1/2"	24	10	22		25
	10084	S1134	3/4"	30	10	25		10
	10085	S1101	1"	36	10	29		5
	10154	SF1118	1/8"F	13	6	16		100

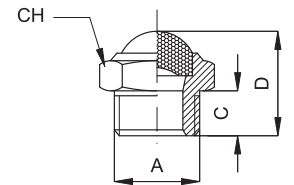

SX11 Niplo: AISI 304 **Parte filtrante:** Rete acciaio inox AISI 304
 Nipple: AISI 304 **Filter:** Net in stainless steel AISI 304



INOX Stainless steel	Codice Code	Articolo Article	A	CH	C	D	Prezzo € Price €	Confezione Order Q.ty
	10086	SX11M5	M5	8	4	8		100
	10087	SX1118	1/8"	13	6	15		50
	10088	SX1114	1/4"	16	8	18		50
	10089	SX1138	3/8"	19	8	19		25
	10090	SX1112	1/2"	24	9	22		20
	10091	SX1134	3/4"	30	10	25		10
	10092	SX1101	1"	36	12	30		5

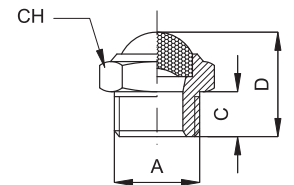

Su richiesta fornibili nella versione in AISI 316L - On request available in AISI 316L

SXN11 Niplo: AISI 304 **Parte filtrante:** Rete acciaio inox AISI 304
 Nipple: AISI 304 **Filter:** Net in stainless steel AISI 304



INOX Stainless steel	Codice Code	Articolo Article	A	B	CH	C	D	Prezzo € Price €	Confezione Order Q.ty
	10240	SXN1118	1/8NPT	11	13	7,5	16,5		50
	10181	SXN1114	1/4NPT	14	16	10	20,5		50
	10241	SXN1138	3/8NPT	17	19	11	22		25
	10242	SXN1112	1/2NPT	22	24	13	26		20
	10299	SXN1134	3/4NPT	28	30	15	30		10
	10300	SXN1101	1NPT	34	36	19	37		5

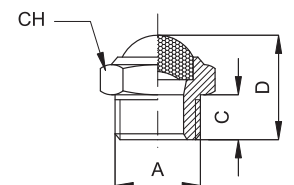

Su richiesta fornibili nella versione in AISI 316L - On request available in AISI 316L

SP11 Niplo: Nylon **Parte filtrante:** Rete acciaio inox AISI 304
 Nipple: Nylon **Filter:** Net in stainless steel AISI 304



	Codice Code	Articolo Article	A	CH	C	D	Prezzo € Price €	Confezione Order Q.ty
Nylon Nylon	10224	SP1118NE	1/8"	13	6	16		50
	10225	SP1114NE	1/4"	16	8	19		50
	10226	SP1138NE	3/8"	19	7,5	19		25
	10227	SP1112NE	1/2"	24	10	23		25

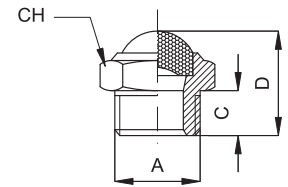

S12 Niplo: Ottone **Parte filtrante:** Bronzo sferico sinterizzato 36 µm
 Nipple: Brass **Filter:** Spherical sintered bronze 36 µm



	Codice Code	Articolo Article	A	B	C	Prezzo € Price €	Confezione Order Q.ty
Ottone e bronzo Brass and bronze	10215	S124	4	15	10		100
	10093	S126	6	18	13		100
	10094	S128	8	25	17		50

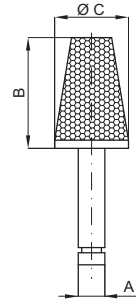

S13 Niplo e parte filtrante: Bronzo sferico sinterizzato 36 µm
 Nipple and filter: Spherical sintered bronze 36 µm



	Codice Code	Articolo Article	A	B	CH	C	D	Prezzo € Price €	Confezione Order Q.ty
Bronzo Bronze	10095	S1318	1/8"	8	13	6	28		100
	10096	S1314	1/4"	12	17	8	34		50
	10097	S1338	3/8"	15	22	10	36		50
	10098	S1312	1/2"	19	27	12	44		25
	10099	S1334	3/4"	22	32	14	54		10
	10100	S1301	1"	28	41	16	66		5

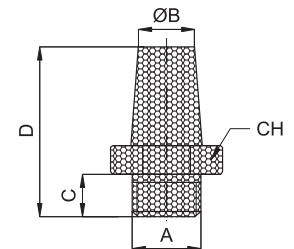

S14 Niplo e parte filtrante: Bronzo sferico sinterizzato 36 µm
 Nipple and filter: Spherical sintered bronze 36 µm



	Codice Code	Articolo Article	A	B	C	E	D	Prezzo € Price €	Confezione Order Q.ty
Bronzo Bronze	10101	S1418	1/8"	11	5,5	8	21		100
	10102	S1414	1/4"	14	9	10,5	27		50
	10103	S1438	3/8"	18	11	15	36		50
	10104	S1412	1/2"	24	11	19	44		25
	10105	S1434	3/4"	30	13	23,5	65		10
	10106	S1401	1"	36	15	26	75		5

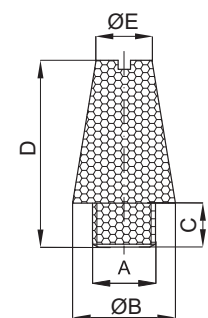

S15 Niplo: Acciaio ramato **Parte filtrante:** Bronzo sferico sinterizzato 36 µm
 Nipple: Copper plated steel **Filter:** Spherical sintered bronze 36 µm



	Codice Code	Articolo Article	A	B	CH	C	D	Prezzo € Price €	Confezione Order Q.ty
Acciaio ramato e bronzo Copper plated steel and bronze	10107	S1518	1/8"	12	8	4,5	22		100
	10108	S1514	1/4"	15	10	6	28		50
	10109	S1538	3/8"	19	13	8	37		50
	10110	S1512	1/2"	23	15	9	44		25
	10111	S1534	3/4"	30	19	10	56		10
	10112	S1501	1"	37	24	12	67		5

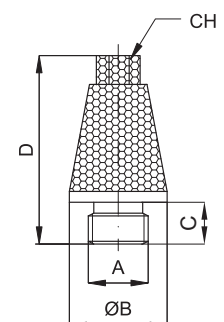

1

S16

Corpo: Alluminio **Cartuccia:** Fibra fonoassorbente rivestita in lamiera forata
Body: Alluminium **Cartridge:** Noise absorbing fibre cloted by metal drilled plate

Alluminio Alluminium	Codice Code	Articolo Article	A	B	C	D	E	Prezzo € Price €	Confezione Order Q.ty
	10113	S1618	1/8"	49	80	70	10		10
	10114	S1614	1/4"	49	106	93	13		10
	10115	S1638	3/8"	70	126	113	13		5
	10116	S1612	1/2"	86	146	132	13		5
	10117	S1634	3/4"	89	179	162	17		1
	10118	S1601	1"	103	212	192	20		1
	10119	S1641	1 1/4"	103	219	192	26		1
	10120	S1621	1 1/2"	136	351	318	33		1
	10121	S1602	2"	136	484	450	33		1

Su richiesta fornibili per utilizzo P_{max.} 40 BAR - On request available for pressure up to 40 BAR max.

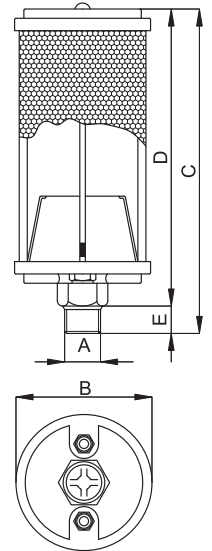
S16B

Corpo: Alluminio **Cartuccia:** Fibra fonoassorbente rivestita in lamiera forata
Body: Alluminium **Cartridge:** Noise absorbing fibre cloted by metal drilled plate

Alluminio Alluminium	Codice Code	Articolo Article	A	B	C	D	E	F	Prezzo € Price €	Confezione Order Q.ty
	10123	S16B03	3"	179	623	421	56	219		1
	10124	S16B04	4"	205	623	563	60	248		1
	10125	S16B06	6"	288	815	732	83	348		1

Su richiesta fornibili per utilizzo P_{max.} 40 BAR - On request available for pressure up to 40 BAR max.

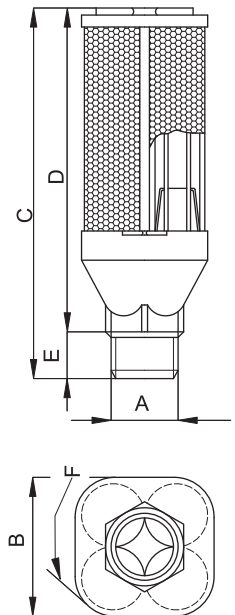
S21

Corpo: Acciaio zincato **Cartuccia:** Acciaio inox
Body: Zinc-plated steel **Cartridge:** Stainless steel

Acciaio zincato e inox Zinc-plated steel and stainless steel	Codice Code	Articolo Article	A	B	CH	C	D	Prezzo € Price €	Confezione Order Q.ty
	10199	S2118	1/8"	28	11	35	11		50
	10200	S2114	1/4"	33	14	44	14		25
	10201	S2138	3/8"	43	18	56	17,5		10
	10202	S2112	1/2"	52	22	68	22		10
	10203	S2134	3/4"	64	27	81	27		5
	10204	S2101	1"	76	33	98	33		1
	10205	S2141	1-1/4"	90	46	113	42		1
	10206	S2121	1-1/2"	100,6	50	124,2	50		1
	10207	S2102	2"	114,7	60	141,2	60		1

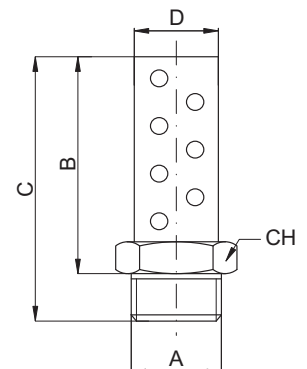



S17 **Corpo:** Resina acetica **Parte filtrante:** Feltro pressato e rete di alluminio
Body: Acetalic resin **Filter:** Pressed felt and aluminium net

Resina acetica Acetalic resin	Nero / Black		Blu / Blue		Bianco / White		A	B	CH	C	D	E	F	Prezzo Price €	Confezione Order Q.ty
	Codice Code	Articolo Article	Codice Code	Articolo Article	Codice Code	Articolo Article									
	10126	S1718NE	10053	S1718BL	10158	S1718BI	1/8"	15,5	10	6	25,5	33	2,5		100
	10127	S1714NE	10060	S1714BL	10159	S1714BI	1/4"	19,5	12	8	32	43	3		50
	10128	S1738NE	10122	S1738BL	10160	S1738BI	3/8"	24,5	16	11	44	58	3		50
	10129	S1712NE	10155	S1712BL	10161	S1712BI	1/2"	24,5	16	11	44	58	3		25

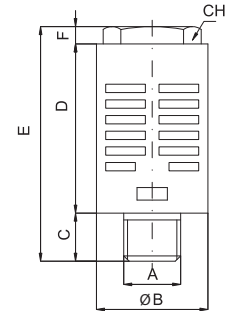

S17 **Corpo:** Resina acetica **Parte filtrante:** Feltro pressato e rete di alluminio
Body: Acetalic resin **Filter:** Pressed felt and aluminium net

Resina acetica Acetalic resin	Nero / Black		Blu / Blue		Giallo / Yellow		A	B	C	D	Prezzo Price €	Confezione Order Q.ty
	Codice Code	Articolo Article	Codice Code	Articolo Article	Codice Code	Articolo Article						
	10130	S1734NE	10156	S1734BL	10162	S1734GI	3/4"	48	18	115		10
	10131	S1701NE	10157	S1701BL	10163	S1701GI	1"	48	18	115		5

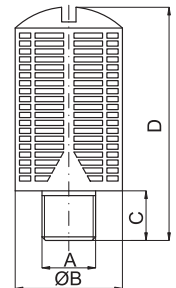

S18 **Corpo:** Resina acetica **Parte filtrante:** Granulato in resina acetica
Body: Acetalic resin **Filter:** Granulate in acetalic resin

Resina acetica Acetalic resin	Nero / Black		Blu / Blue		Giallo / Yellow		A	B	C	D	Prezzo Price €	Confezione Order Q.ty
	Codice Code	Articolo Article	Codice Code	Articolo Article	Codice Code	Articolo Article						
	10132	S1818NE	10149	S1818BL	10167	S1818GI	1/8"	15	6	32,5		100
	10133	S1814NE	10150	S1814BL	10168	S1814GI	1/4"	19,5	8	43		50
	10134	S1838NE	10151	S1838BL	10169	S1838GI	3/8"	24,5	11	58		50
	10135	S1812NE	10164	S1812BL	10170	S1812GI	1/2"	24,5	11	58		25
	10136	S1834NE	10165	S1834BL	10171	S1834GI	3/4"	48	18	115		10
	10137	S1801NE	10166	S1801BL	10172	S1801GI	1"	48	18	115		5

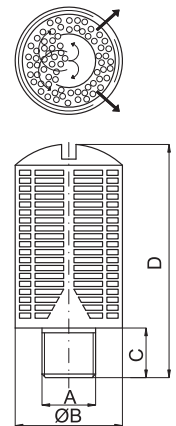

S19 **Nipplo:** Nylon **Parte filtrante:** Polietilene
Nipple: Nylon **Filter:** Polyethylene

Polietilene Polyethylene	Codice Code	Articolo Article	A	B	C	D	Prezzo € Price €	Confezione Order Q.ty
		10138	S19M5	M5	7	5	24	
	10139	S1918	1/8"	13	7	32		100
	10140	S1914	1/4"	17	8	39		50
	10141	S1938	3/8"	25	11	65		50
	10142	S1912	1/2"	25	11,5	70		25
	10143	S1934	3/4"	37	15,5	138		10
	10144	S1901	1"	48	19,5	158		5

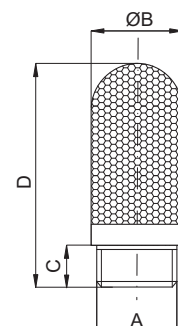

1



S20 Niplo: Poliacetalico Parte filtrante: Polietilene
 Nipple: Polyacetal Filter: Polyethylene

Polietilene Polyethylene	Codice Code	Articolo Article	A	B	C	D	Prezzo € Price €	Confezione Order Q.ty
	10145	S2018	1/8"	15.2	5.3	35.6		100
10146	S2014	1/4"	19.2	6.5	57.4		50	
10147	S2038	3/8"	33.2	9	77.8		50	
10148	S2012	1/2"	43	10	87.4		25	
10311	S2034	3/4"	44.5	11.5	119.5		10	
10312	S2001	1"	55	13	125		5	

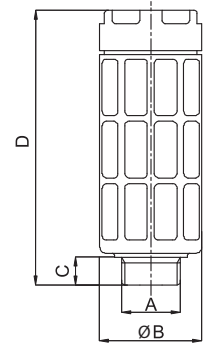

S22 Niplo: Nylon Parte filtrante: Polietilene
 Nipple: Nylon Filter: Polyethylene

Polietilene Polyethylene	Codice Code	Articolo Article	A	B	C	D	Prezzo € Price €	Confezione Order Q.ty
	10209	S226	6	13	26	47		100
10210	S228	8	13.5	24	46		100	
10211	S2210	10	15.5	32	59		50	
10212	S2212	12	18.5	54.5	83		50	

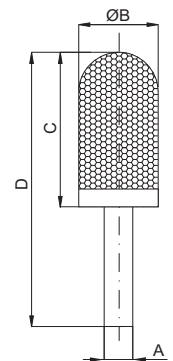
FLFF

Corpo: Ottone nichelato Parte filtrante: Bronzo sferico sinterizzato 36 µm
 Body: Nickel plated brass Filter: Spherical sintered bronze 36 µm



Ottone nichelato e bronzo Nickel plated brass and bronze	Codice Code	Articolo Article	Filetto Thread	Prezzo € Price €	Confezione Order Q.ty
	10313	FLFF18	1/8"		100
	10222	FLFF14	1/4"		100
	10314	FLFF38	3/8"		50
	10315	FLFF12	1/2"		50

FLMF

Corpo: Ottone nichelato Parte filtrante: Bronzo sferico sinterizzato 36 µm
 Body: Nickel plated brass Filter: Spherical sintered bronze 36 µm



Ottone nichelato e bronzo Nickel plated brass and bronze	Codice Code	Articolo Article	Filetto Thread	Prezzo € Price €	Confezione Order Q.ty
	10316	FLMF18	1/8"		100
	10217	FLMF14	1/4"		100
	10317	FLMF38	3/8"		50
	10318	FLMF12	1/2"		50