

Adattatori, staffe, riduzioni, distanziali

Adapters, brackets, reductions, distancers

Adattatori Adapters

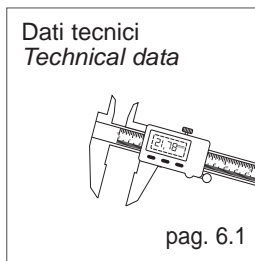

Staffe Brackets

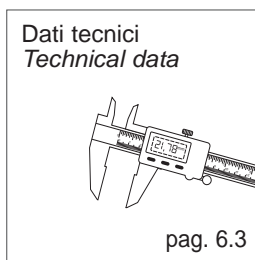

Riduzioni Reductions

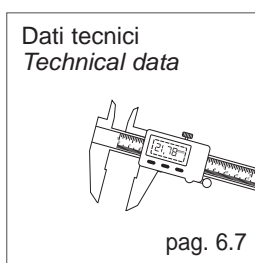

Distanziali Distancers

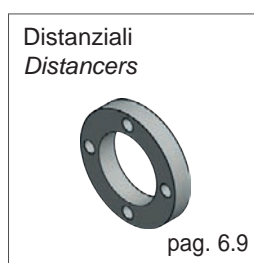
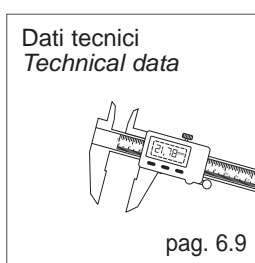

Adattatori standard - Standard adapters

Serie di adattatori standard per collegamento attuatore/valvola. Quadro standard verso il lato attuatore e non lavorato verso la valvola. Materiale acciaio Inox AISI 303. Quadro secondo norme ISO 5211-DIN 3337-NAMUR.

Standard adapters series for actuator/valve connection. Standard square toward the actuator and semifinished to the valve side. Material Stainless Steel AISI 303. Squares according ISO 5211-DIN 3337-NAMUR.

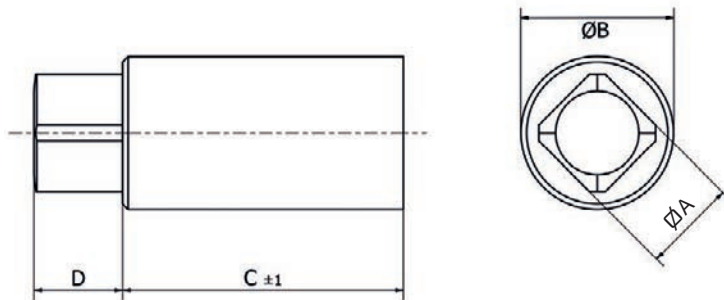

Codice Code	48218	48219	48220	48221	48222	48223	48224	48225
Articolo Article	GTA092060	GTA112060	GTA112560	GTA113060	GTA142060	GTA142560	GTA143060	GTA143560
ØA	9x9	11x11	11x11	11x11	14x14	14x14	14x14	14x14
ØB	20	20	25	30	20	25	30	35
C	60	60	60	60	60	60	60	60
D	10	12	12	12	15	15	15	15

Codice Code	48226	48227	48228	48229	48230	48231	48232	48233
Articolo Article	GTA172560	GTA173060	GTA173560	GTA174080	GTA174560	GTA223580	GTA224080	GTA224580
ØA	17x17	17x17	17x17	17x17	17x17	22x22	22x22	22x22
ØB	25	30	35	40	45	35	40	45
C	60	60	60	80	60	80	80	80
D	18	18	18	18	18	23	23	23

Codice Code	48234	48235	48236	48237	48238	48239	48240	48241
Articolo Article	GTA225080	GTA273575	GTA274080	GTA274580	GTA275580	GTA366090	GTA4660120	GTA5570170
ØA	22x22	27x27	27x27	27x27	27x27	36x36	46x46	55x55
ØB	50	35	40	45	55	60	60	70
C	80	75	80	80	80	90	120	170
D	23	28	28	28	28	37	47	58

Codifica - Code Key

GTA 00 00 00

A B C

Nota: quote B e C modificabili su richiesta
 Note: B and C quotes changeable on request

Adattatori personalizzati - Tailored adapters

A richiesta fornibili completi di lavorazione dal lato valvola secondo indicazioni, come da esempio riportato sotto.
Per informazioni contattare l'ufficio commerciale.

*On request supplied machined on the valve side according to customers request, as the example below.
For information, please contact the sales department.*

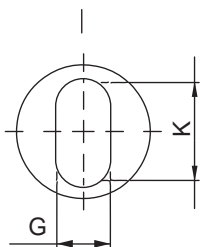
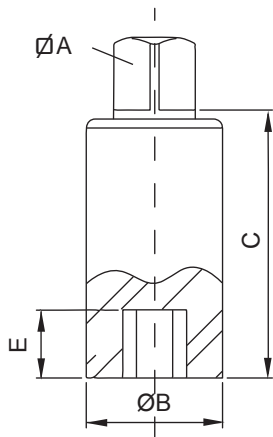

LA

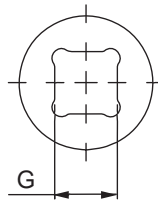

LB

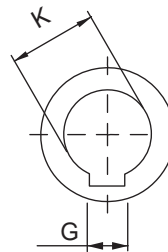

LC

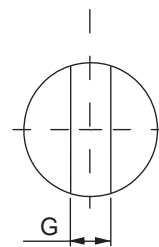

LD

Codifica - Code Key

GTA **00** **00** **00** **00** **0** **00** **00** **00**

A B C E G K

LA = rif. disegno LA
see drawing

LB = rif. disegno LB
see drawing

LC = rif. disegno LC
see drawing

LD = rif. disegno LD
see drawing

00 = rif. disegno LA
see drawing

90 = 90°

Esempio - Example

GTA 11 20 30 LD 08 00 00

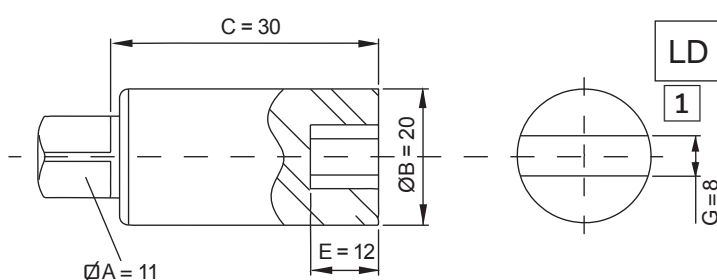

Staffe in acciaio zincato - Zinc-coated steel brackets

Staffe di montaggio a norma DIN EN 15081

- Per l'assemblaggio di attuatori su valvole secondo norma ISO 5211: 2001 DIN 3337
- Spigoli arrotondati
- Tolleranze secondo normative
- Materiale: acciaio zincato

Mounting brackets conforming to DIN EN 15081

- For the assembly of pneumatic actuators on top of the valves conforming to norm ISO 5211: 2001 DIN 3337
- Rounded corners
- Tolerances according to normative
- Material: zinc-plated steel

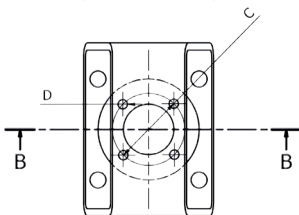
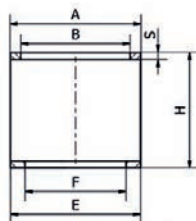
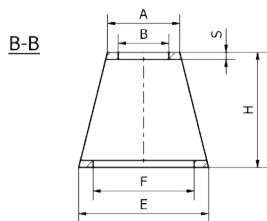
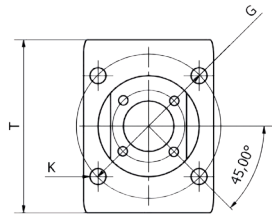

Modello / Model :

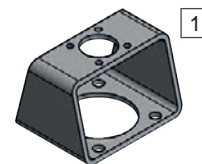

Codice Code	48242	48243	48244	48245	48246	48247	48248	48249	48250
Articolo Article	BRK000303	BRK000304	BRK000305	BRK000307	BRK000404	BRK000405	BRK000407	BRK000505	BRK000507
ISO 5211	F03-F03	F03-F04	F03-F05	F03-F07	F04-F04	F04-F05	F04-F07	F05-F05	F05-F07
Modello Model	1	1	1	1	1	1	1	1	1
A	33,5	35	35	35	45	45	45	50	50
B	25	25	25	25	30	30	30	35	35
C	36	36	36	36	42	42	42	50	50
D	5,5	5,5	5,5	5,5	5,5	5,5	5,5	6,5	6,5
E	33,5	45	50	70	45	50	70	50	70
F	25	30	35	55	30	35	55	35	55
G	36	42	50	70	42	50	70	50	70
K	5,5	5,5	6,5	9	5,5	6,5	9	6,5	9
T	80	100	100	100	100	100	100	100	100
H	40	60	60	60	60	60	60	60	60
S	3	5	5	5	5	5	5	5	5

Codice Code	48251	48252	48253	48254	48255	48256	48257	48258
Articolo Article	BRK000510	BRK000512	BRK000707	BRK000710	BRK000712	BRK000714	BRK001010	BRK001012
ISO 5211	F05-F10	F05-F12	F07-F07	F07-F10	F07-F12	F07-F14	F10-F10	F10-F12
Modello Model	1	1	1	1	1	1	1	1
A	50	50	70	70	70	70	90	90
B	35	35	55	55	55	55	70	70
C	50	50	70	70	70	70	102	102
D	6,5	6,5	9	9	9	9	11	11
E	90	110	70	90	110	135	90	110
F	70	85	55	70	85	100	70	85
G	102	125	70	102	125	140	102	125
K	11	13	9	11	13	17	11	13
T	140	140	100	140	140	160	140	140
H	80	80	60	80	80	90	80	80
S	6	6	5	6	6	6	6	6

Codice Code	48259	48260	48261	48262	48263	48264	48265	48266
Articolo Article	BRK001014	BRK001016	BRK001212	BRK001214	BRK001216	BRK001414	BRK001416	BRK001616
ISO 5211	F10-F14	F10-F16 *	F12-F12	F12-F14	F12-F16 *	F14-F14	F14-F16 *	F16-F16 *
Modello Model	1	1	1	1	1	1	1	1
A	90	90	110	110	110	135	135	160
B	70	70	85	85	85	100	100	130
C	102	102	125	125	125	140	140	165
D	11	11	13	13	13	17	17	21
E	135	160	110	135	160	135	160	160
F	100	130	85	100	130	100	130	130
G	140	165	125	140	165	140	165	165
K	17	21	13	17	21	17	21	21
T	160	220	140	160	220	160	220	220
H	90	120	80	90	120	90	120	120
S	6	10	6	6	10	6	10	10

* Nota: Queste staffe vengono fornite senza trattamento di zincatura, ma rivestite con vernice epossidica nera.

* Note: These brackets are supplied without galvanizing, but coated with black epoxy paint.

Staffe in acciaio Inox - Stainless steel brackets

Staffe di montaggio in acciaio Inox AISI 304 a norma DIN EN 15081

- Per l'assemblaggio di attuatori su valvole secondo norma ISO 5211: 2001 DIN 3337
- Bordi arrotondati
- Tolleranze secondo normative
- Materiale: acciaio Inox AISI 304

Mounting brackets in stainless steel AISI 304 conforming to DIN EN 15081

- For the assembly of pneumatic actuators on top of the valves conforming to norm ISO 5211: 2001 DIN 3337
- Rounded corners
- Tolerances according to normative
- Material: stainless steel AISI 304

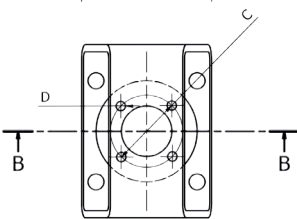
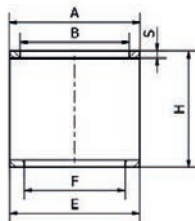
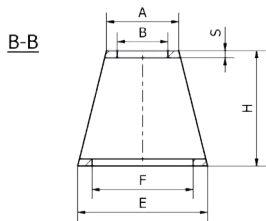
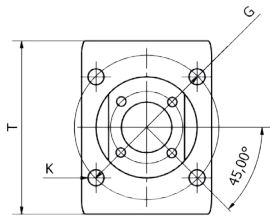

Modello / Model :

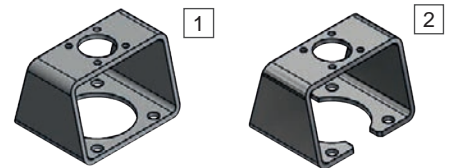

Codice Code	48267	48268	48269	48270	48271	48272	48273	48274	48275
Articolo Article	BRK110303	BRK110304	BRK110305	BRK110307	BRK110404	BRK110405	BRK110407	BRK110505	BRK110507
ISO 5211	F03-F03	F03-F04	F03-F05	F03-F07	F04-F04	F04-F05	F04-F07	F05-F05	F05-F07
Modello Model	1	1	1	1	1	1	1	1	1
A	35	35	35	35	45	45	45	50	50
B	25	25	25	25	30	30	30	35	35
C	36	36	36	36	42	42	42	50	50
D	5,5	5,5	5,5	5,5	5,5	5,5	5,5	6,5	6,5
E	35	45	50	70	45	50	70	50	70
F	25	30	35	55	30	35	55	35	55
G	36	42	50	70	42	50	70	50	70
K	5,5	5,5	6,5	9	5,5	6,5	9	6,5	9
T	80	100	100	100	100	100	100	100	100
H	40	60	60	60	60	60	60	60	60
S	4	5	5	5	5	5	5	5	5

Codice Code	48276	48277	48278	48279	48280	48281	48282	48283
Articolo Article	BRK110510	BRK110512	BRK110707	BRK110710	BRK110712	BRK110714	BRK111010	BRK111012
ISO 5211	F05-F10	F05-F12	F07-F07	F07-F10	F07-F12	F07-F14	F10-F10	F10-F12
Modello Model	2	2	1	2	2	2	2	2
A	50	50	70	70	70	70	90	90
B	35	35	55	55	55	55	70	70
C	50	50	70	70	70	70	102	102
D	6,5	6,5	9	9	9	9	11	11
E	90	110	70	90	110	135	90	110
F	70	85	55	70	85	100	70	85
G	102	125	70	102	125	140	102	125
K	11	13	9	11	13	17	11	13
T	140	140	100	140	140	160	140	140
H	80	80	60	80	80	90	80	80
S	5	5	5	5	5	5	5	5

Codice Code	48284	48285	48286	48287	48288	48289	48290	48291
Articolo Article	BRK111014	BRK111016	BRK111212	BRK111214	BRK111216	BRK111414	BRK111416	BRK111616
ISO 5211	F10-F14	F10-F16	F12-F12	F12-F14	F12-F16	F14-F14	F14-F16	F16-F16
Modello Model	2	2	2	2	2	2	2	2
A	90	90	110	110	110	135	135	160
B	70	70	85	85	85	100	100	130
C	102	102	125	125	125	140	140	165
D	11	11	13	13	13	17	17	21
E	135	160	110	135	160	135	160	160
F	100	130	85	100	130	100	130	130
G	140	165	125	140	165	140	165	165
K	17	21	13	17	21	17	21	21
T	160	220	140	160	220	160	220	220
H	90	120	80	90	120	90	120	120
S	5	5	5	5	5	5	5	5

Riduzioni in acciaio al carbonio - Carbon steel reductions brackets

Riduzioni per assemblaggio di attuatori su valvole con dimensioni secondo normative

- Spigoli arrotondati
- Elevata precisione

Reductions for assembling the actuators on top of the valves according to normative

- Rounded corners
- High precision

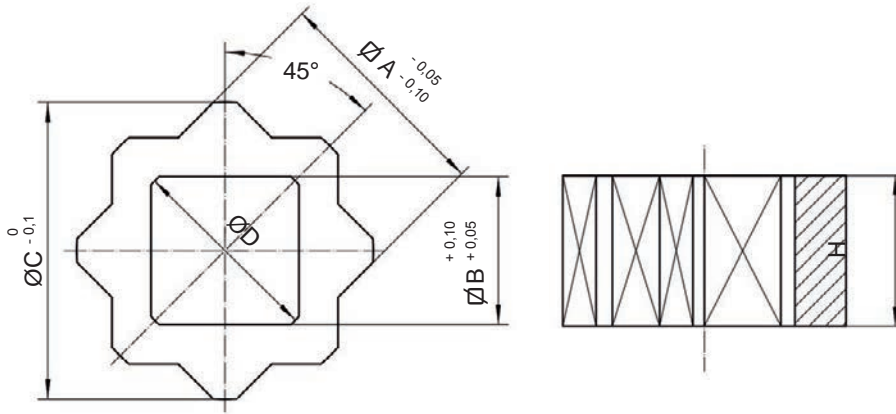

Codice Code	48024	48057	48058	48059	48060	48202
Articolo Article	ADT11M9	ADT14M9	ADT14M11	ADT17M11	ADT17M14	ADT19M11
ØA	11	14	14	17	17	19
ØB	9	9	11	11	14	11
ØC	15	19	19	23	23	26
H	12	16	16	19	19	21
ØD	12	12	14,8	14,8	19	14,8

Codice Code	48203	48204	48061	48062	48205	48063
Articolo Article	ADT19M14	ADT19M17	ADT22M14	ADT22M17	ADT22M19	ADT27M17
ØA	19	19	22	22	22	27
ØB	14	17	14	17	19	17
ØC	26	26	28	28	28	36
H	19	23	24	24	24	29
ØD	21	21	19	23,2	25,2	23,2

Codice Code	48200	48064	48206	48065	48066	48207
Articolo Article	ADT27M19	ADT27M22	ADT36M19	ADT36M22	ADT36M27	ADT46M27
ØA	27	27	36	36	36	46
ØB	19	22	19	22	27	27
ØC	36	36	49	49	49	60,2
H	26	29	38	30,3	38	37,3
ØD	29	30	26	38	37,3	48

Codice Code	48067	48208	48209	48210
Articolo Article	ADT46M36	ADT55M27	ADT55M36	ADT55M46
ØA	46	55	55	55
ØB	36	27	36	46
ØC	60,2	72,2	72,2	72,2
H	50,1	37,3	50,1	64,1
ØD	48	57	57	57

Riduzioni in acciaio Inox - Stainless steel reductions

Accessori per adattamento attuatori su valvole con dimensioni secondo normative

- Spigoli arrotondati
- Elevata precisione

Adapters for assembling the actuators on top of the valves according to normative

- Rounded corners
- High precision

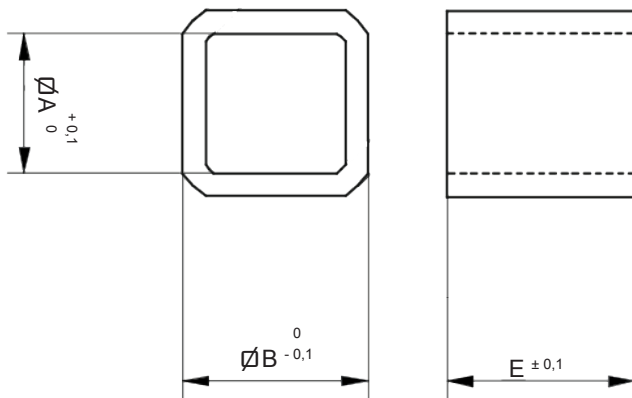

Codice Code	48211	48212	48213	48214	48074	48215	48216	48217
Articolo Article	ADTX11M9	ADTX14M9	ADTX14M11	ADTX17M11	ADTX17M14	ADTX22M17	ADTX27M22	ADTX36M27
$\varnothing A$	9	9	11	11	14	17	22	27
$\varnothing B$	11	14	14	17	17	22	27	36
E	10	15	15	17	17	22	27	36

Distanziali per valvole a farfalla - Distancers for butterfly valves

Distanziali in alluminio per assemblaggio diretto di attuatori rotanti su valvole a farfalla con connessioni ISO 5211- DIN 3337 - NAMUR. Trattamento superficiale di verniciatura epossidica.

Aluminium distancers for rotary actuator's direct mounting on butterfly valves with ISO 5211-DIN 3337-NAMUR connections. Surface epox paint treatment.

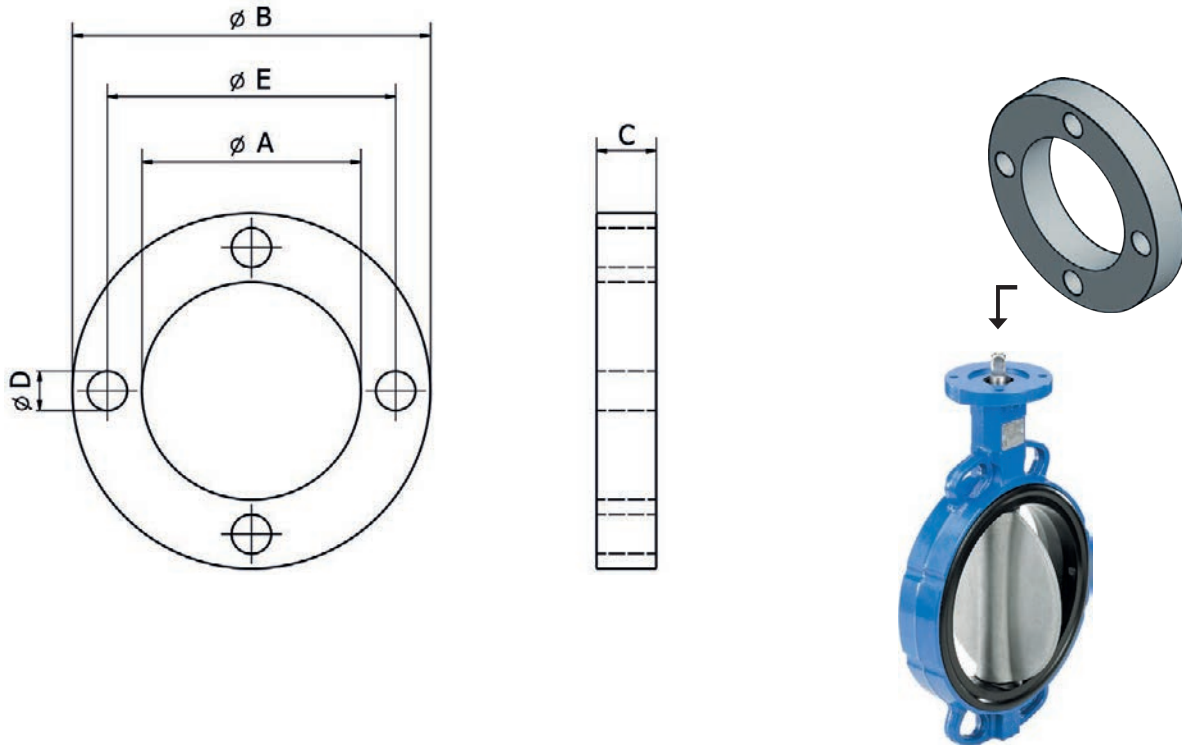

Codice Code	48292	48293	48294	48295
Articolo Article	DVF070500	DVF071500	DVF103700	DVF104500
ISO 5211	F07	F07	F10	F10
ØA	56	56	79	79
ØB	90	90	125	125
C	5	15	37	45
ØD	8	8	10	10
ØE	70	70	102	102